

SELECT SURFACES LAMINATE FLOOR INSTALLATION GUIDE
SHADE: CANYON OAK – ITEM: SCLMF0380U

IMPORTANT: BEGIN INSTALLATION AT THE TOP RIGHT HAND CORNER OF THE ROOM. PLANKS ARE INSTALLED FROM THE RIGHT TO THE LEFT-HAND SIDE OF THE ROOM.

NOTE: It is important to read the instructions before installation.

SUBFLOOR

The ideal conditions are 40%-60% relative humidity. If the rooms have higher levels of humidity, or if the home has a crawlspace and/or cellar or is considered a cottage, please consult a specialist in your area and/or the construction norms.

A) Concrete Floors

- The surface must be absolutely level, dry and clean. Differences in the floor level of more than 6.25 mm per 1.52 m (1/4" per 5 ft.) must be leveled.
- Use a vapor barrier at least 0.15 mm (0.006") thick. Edges should overlap by 200 mm (8").
- Ensure that 25 mm (1") of the vapor barrier is up on the walls.
- Lay down flooring.

B) Wood and other hard surfaces

- The surface must be dry, clean, smooth and level. Slopes steeper than 6.25 mm per 1.52 m (1/4" per 5 ft.) must be leveled.
- Lay down flooring.

C) Carpet and underpadding

- Remove both before laying down the floor, and proceed as outlined in A or B.

D) Vinyl floor surfaces

- Lay down flooring. (If the vinyl is on top of concrete, a moisture barrier must be placed on top of the vinyl before installing the floor).

E) Radiant heat floors

- Follow the installation instructions provided by the radiant heat manufacturer.
- New concrete subfloors must be cured with no heat transfer for 60 days.
- The radiant heating must be operational for two weeks prior to installing the laminate flooring, and the temperature must be maintained between 18-22°C (65-72°F).
- Keep the temperature below 27°C (80°F) at all times.
- Slight gaps may occur between laminate planks installed over radiant heating and will not be covered by the warranty.

PREPARATION

- 1) Leave closed packages in a horizontal position in the room for 48 hours prior to installing.
- 2) Sub floor needs to be prepared (as above).
- 3) There must be at least 12.5 mm (1/2") between the surface of the floor and the bottom of electrical baseboard heater to allow heat to circulate.
- 4) Verify door and frame clearances and make required adjustments before laying down the floor. Cut the door molding with a saw to allow planks to slide underneath. (See figure A.)
- 5) Carefully remove existing baseboards.
- 6) Decide in which direction the planks should be laid. As a rule, the floor planks should be laid perpendicular to the wall that has a window in it. To make the room appear larger, it may be preferable to lay down the floor planks parallel to the longest wall.
- 7) Before installing, check panels for defects such as chips and color or sheen differences under good light conditions. Check that the channel is clean and free of debris. Damaged planks must be replaced before laying down the floor.
- 8) A minimum expansion area is required around the perimeter of the room as well as any fixed object (door frame, fireplace mantle, etc.): 10 mm (3/8") for rooms 7.6 m (25 ft.) long or wide, 15 mm (5/8") for rooms greater than 7.6 m (25 ft.).

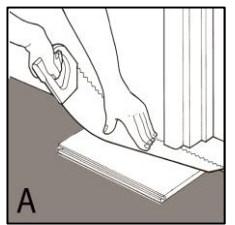

TOOLS AND SUPPLIES REQUIRED

Hand or power saw (fine-toothed blade), chalk line/string, spacers, set square, vapor barrier: min. 0.15 mm /0.006" (for installation on concrete and radiant heat floors), pencil, tape measure, tapping block, rubber mallet, pull bar, utility knife.

NOTE: Safety glasses and gloves should be worn at all times.

INSTALLATION

THIS PRODUCT IS PRIMARILY MADE OF WOOD MATERIAL AND NEEDS ROOM TO EXPAND AND CONTRACT. DO NOT ATTACH THE FLOOR TO ANY SURFACE. ALWAYS ALLOW AN EXPANSION GAP AT THE PERIMETER AND AROUND ALL OBSTACLES

1. Installation method: the planks click together at a 45° angle on the length side (see figure B). Note that a tapping block and mallet may be used for a tighter fit along the lengths of planks. Do not use excessive force, as this may damage the tongue and/or groove. Connecting the short ends together **must** be done using a tapping block and mallet – tapping the tongue into the groove (see figure C). When installing the last plank in a row, it may be necessary to use a pull bar. Place the pull bar between the wall and the laminate and gently tap on the lip on top (see figure D).
2. Measure the room to establish its squareness and the width of the last row. If the width of the last row is less than 50 mm (2"), not including the bottom lip of the groove, the first row will have to be cut accordingly. The tongue on the first row of planks and the bottom lip of the groove side on the last row of the planks should also be removed.
3. Irregular wall along the first row of planks - scribe the planks to fit the wall and cut.
4. When cutting a plank, if using a portable electric saw (jigsaw), the decorative surface must face up. If using a circular table saw, the decorative surface must face down.
5. **Begin installation on the top right hand corner of the room**, with the tongue side against the starting wall. Always place a 10-15 mm (3/8"-5/8") spacer between the wall or any fixed object (door frame, fireplace mantle, etc.) and the plank on either side of each joint and at the far ends of each plank.
6. The first and last plank in a row must be at least 300 mm (12") long. Measure the first row before installing. To avoid ending the row with a plank of less than 300 mm (12") in length, it may be necessary to cut the first plank. Always remove the groove on the last plank. For the first plank of the second row, use the cut plank left over from the first row provided it is more than 300 mm (12") long. If it is less than 300 mm (12") long, use a new plank, cutting it so it is at least 300 mm (12") away from the joint of the first plank on the first row. Always remove the bottom lip of the groove and the tongue from the ends of the planks against the walls (see figure E).
7. Continue laying down the floor from right to left. For a stronger and more natural looking floor, make sure to stagger the joints in each row by at least 200 mm (8"). Remove the spacers and install moldings and trims. Never nail the moldings to the laminate floor.
8. Install a T-molding in every doorway, and in any room where the floor is wider or longer than 10 m (33 ft). This will allow the floor to expand and contract naturally.
9. Do not nail or screw fixtures to the flooring. Do not install kitchen cabinets or islands on top of the laminate flooring, as the weight of these can impede the natural expansion and contraction of the floor.

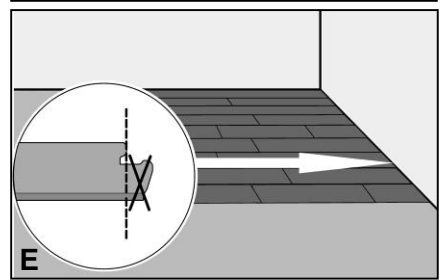
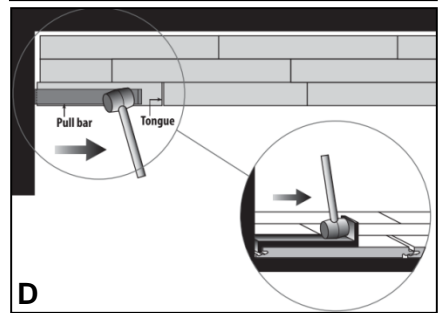
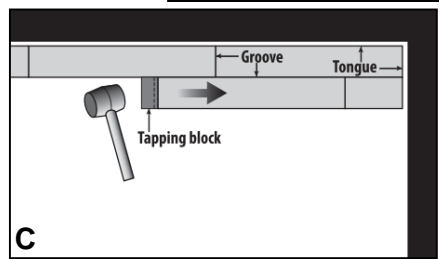
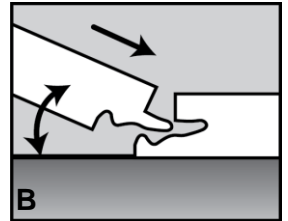

CARE AND MAINTENANCE

- Remove dust and dirt with a broom or vacuum.
- Clean floor using a damp cloth or mop if necessary. Do not wet mop the floor.
- Do not use soap based cleansers or abrasive detergents.
- Wipe up spills immediately.
- Never let water stand on the floor for any length of time
- Use area rugs in entrances and high traffic areas.
- Use rubber floor protectors under furniture.
- Maintain the humidity level in the installation space between 40% and 60% year round. It may be necessary to use a dehumidifier in periods of high humidity and a humidifier in periods of low humidity.

WARRANTY

Select Surfaces affirms that the enclosed flooring is covered with a **limited lifetime residential warranty** to the original purchaser. The stipulations of this warranty are as follows:

- The flooring will be free of manufacturing defects.
- The flooring surface will not wear through under normal usage.
- The flooring will not stain.
- The flooring will not fade due to exposure to lighting or UV rays.

The following conditions apply to the warranty and may void the warranty if not followed correctly:

- The flooring must be installed according to the instructions provided by the manufacturer. The owner must follow the care and maintenance guidelines.
- If filing a warranty claim it must be submitted within 30 days of the discovery of the damage.
- Surface wear must be evident and visible, measuring at least 13 cm² (2 square inches).
- Proof of purchase, such as a bill of sale is mandatory when requesting warranty service.
- Removing flooring prior to contacting Select Surfaces Claim Department voids the warranty.
- The manufacturer reserves the right to designate a representative to inspect the floor in question and remove samples for analysis.
- The warranty includes the replacement material, excludes labor cost and any other secondary costs.
- The warranty applies only to the original purchaser and is non-transferable.
- The warranty only applies to flooring installed in appropriate indoor, residential environments.
- Upon approval of a warranty claim, Select Surfaces will provide the claimant with instructions on how to proceed to have the flooring repaired or replaced. The claimant has 90 days to comply with the instructions. If the claimant fails to do so within 90 days, all rights under the limited warranty are waived.

WARRANTY EXCLUSIONS

- Damage due to improper installation, care, cleaning, or maintenance.
- Damage caused by severe impact, scratching, cutting, fire, water damage, alterations, or any other wear or damage caused by acts of God.
- Damage caused by water or any other liquids, such as swelling and bubbling.
- Flooring installed in bathrooms or laundry rooms are not covered by the warranty.
- Peeling and wear in beveled-edged products along the edge of the panels less than 5 mm (3/16") from the edge is not covered by the warranty.
- The limited lifetime residential warranty does not apply to moldings.
- The warranty applies only to flooring purchased through an authorized dealer.

DISCLAIMERS

- Select Surfaces offers no other warranty, expressed or implied. This warranty replaces all other warranties.
- Certain states and countries do not allow limitations on damages, so the above warranty limitations and exclusions may not apply to you.

FILING A CLAIM

Any claim under the above warranty must be made within 30 days after the issue is detected by contacting Technical Support by email at techsupport@selectsurfaces.ca or by telephone at 1 855-250-8167. Proof of purchase (indicating the date of purchase) must be presented to file a claim. Select Surfaces reserves the right to send a representative to inspect the floor and remove samples for analysis. If the claimant fails to give reasonable cooperation to the representative to inspect the flooring and remove samples, Select Surfaces shall be under no obligation to provide any remedies to the claimant.

*Important to note: The owner/purchaser must inspect for color, finish and the quality before installation. The manufacturer cannot be held responsible for costs incurred when a floor with visible defects has been installed.

⚠ Caution

PROPOSITION 65 WARNING: Drilling, sawing, sanding, or machining wood products generates wood dust, a substance known to the state of California to cause cancer.

Precautionary measures: If dust level is high, avoid inhalation of wood dust by wearing the appropriate NIOSH designated dust mask. Use adequate personal protective equipment to avoid dust contact with eyes and skin. Equip machine power tools with a dust collector to reduce the emission of wood dust.

IMPORTANT HEALTH NOTICE FOR MINNESOTA RESIDENTS ONLY: SOME OF THE BUILDING MATERIALS USED IN THIS HOME (OR THESE BUILDING MATERIALS) EMIT FORMALDEHYDE. EYE, NOSE, AND THROAT IRRITATION, HEADACHE, NAUSEA AND A VARIETY OF ASTHMA-LIKE SYMPTOMS, INCLUDING SHORTNESS OF BREATH, HAVE BEEN REPORTED AS A RESULT OF FORMALDEHYDE EXPOSURE. ELDERLY PERSONS AND YOUNG CHILDREN, AS WELL AS ANYONE WITH A HISTORY OF ASTHMA, ALLERGIES, OR LUNG PROBLEMS, MAY BE AT GREATER RISK. RESEARCH IS CONTINUING ON THE POSSIBLE LONG-TERM EFFECTS OF EXPOSURE TO FORMALDEHYDE. REDUCED VENTILATION MAY ALLOW FORMALDEHYDE AND OTHER CONTAMINANTS TO ACCUMULATE IN THE INDOOR AIR. HIGH INDOOR TEMPERATURES AND HUMIDITY RAISE FORMALDEHYDE LEVELS. WHEN A HOME IS TO BE LOCATED IN AREAS SUBJECT TO EXTREME SUMMER TEMPERATURES, AN AIR-CONDITIONING SYSTEM CAN BE USED TO CONTROL INDOOR TEMPERATURE LEVELS. OTHER MEANS OF CONTROLLED MECHANICAL VENTILATION CAN BE USED TO REDUCE LEVELS OF FORMALDEHYDE AND OTHER INDOOR AIR CONTAMINANTS. IF YOU HAVE ANY QUESTIONS REGARDING THE HEALTH EFFECTS OF FORMALDEHYDE, CONSULT YOUR DOCTOR OR LOCAL HEALTH DEPARTMENT.

For questions regarding installation, please contact our **Technical Support Department** by email at techsupport@selectsurfaces.ca or by telephone at 1 855-250-8167. To purchase matching **moldings**, please contact our **Customer Service Department** at info@selectsurfaces.ca or visit www.selectsurfaces.ca.

Scan to view installation video:



IMPORTANT INSTALLATION INFORMATION

NOTE: IT IS IMPORTANT TO READ THE FULL INSTALLATION GUIDE PRIOR TO BEGINNING YOUR INSTALLATION.

SPECIAL INSTALLATION EQUIPMENT REQUIRED:

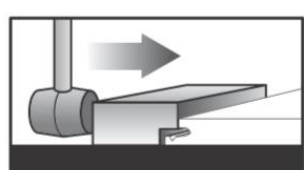

OTHER TOOLS:

Hand or power saw (fine-toothed carbide blade), chalk line/string, spacers, set square, vapor barrier: min. 0.006"/0.15 mm (for installation on concrete and radiant heat floors), pencil, tape measure, tapping block, rubber mallet, pull bar, utility knife.

Always install a vapor barrier of 0.006" (0.15 mm) over concrete or radiant heat floors.

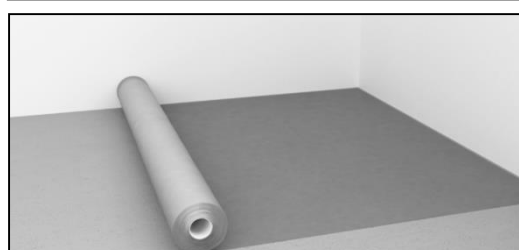

It is necessary to install a T-molding in any room that is greater than 33 ft (10 m) in either length or width.

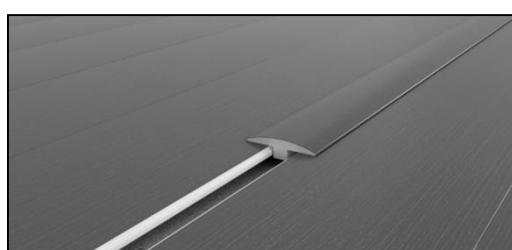

For rooms less than 25 ft (7.6 m) long or wide, leave an expansion gap of 3/8" (10 mm).



For rooms greater than 25 ft (7.6 m) long or wide, leave an expansion gap of 5/8" (15 mm).

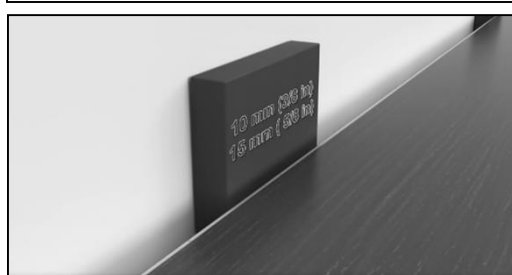

Begin the installation at the top right-hand corner of the room. Install each row from right-to-left.



The tongue clicks into the groove.

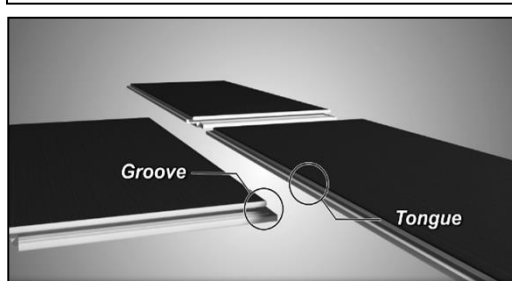

The planks click together at a 45° on the length side.

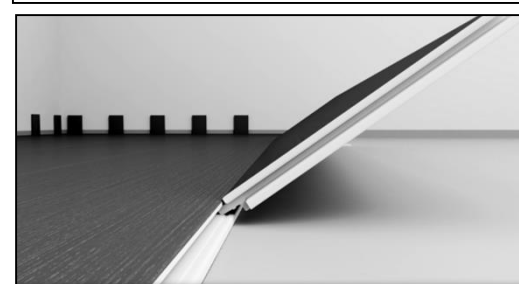

On the short end of the plank, tap the boards gradually into place using a rubber mallet against the tapping block.

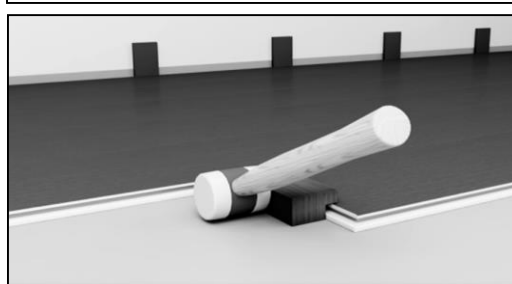

Use a pull bar to install the last plank in a row. Place one end of the pull bar between the wall and the plank and gently tap the other end of the pull bar.

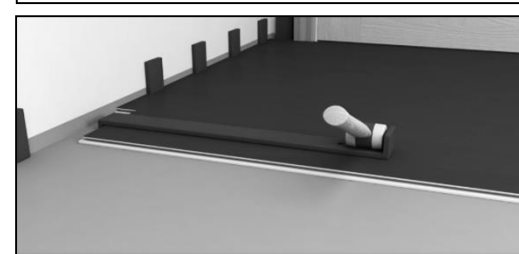

Visit www.selectsurfaces.ca or www.samsclub.com to view a complete installation video.

HAVING TROUBLE?
WE CAN HELP

CONTACT US
techsupport@selectsurfaces.ca
1-855-250-8167

SELECT
SURFACES